

marmorin

BATHROOM 2013



COLOUR SELECTION OF PRODUCTS

GELCOAT® MATERIAL

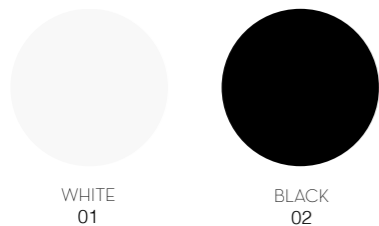

WHITE
01

BLACK
02

GELCOAT® MAT MATERIAL



WHITE MAT
31

SOLID® MATERIAL*



WHITE
51

* The dimensions of the product manufactured in the solid® material technology may differ slightly from those specified in the catalogue (they may be smaller by 0.5% to 0.6%).

CATALOGUE INDEXING EXAMPLE

GELCOAT® MATERIAL 000 000 020 XX X
 GELCOAT® MAT MATERIAL 000 000 040 XX X
 SOLID® MATERIAL 000 000 060 XX X

XX MEANS COLOUR - ACCORDING TO THE ABOVE COLOUR RANGE / CLASSIFICATION

X means the quantity of tap openings
 0 - without tap opening
 1 - 1 tap opening
 2 - 2 tap openings

ATTENTION! The colours may vary slightly from the actual colours.



MY STORY

My story could begin like a fairy tale: „A long time ago there once lived a human being in a small village... He was interested in exploring the world, meeting people and learning – therefore he left the village and his family in order to get educated...”

We could say that you are reading that story after 40 years but its ending does not have to be different from the fairy tale. Life is about being happy and fulfilled!

I chose a very difficult path by deciding to create something which will be verified a dozen times each day by every person who decides to purchase a bathroom or kitchen sink made by me. That person will not only estimate one day or one moment when the decision is made but throughout many years of trials, also in terms of aesthetics.

I thought: After all, an object which is present in your everyday life, an object you look at and use so often, must be perfect!

Whatever I create can never let down or become boring.

Bogdan Hrab

SINCE 1985



Starkowo

Curious as it may seem, love of hard work must somehow run deep in the genes of Great Poland natives. Is it a wonder we cannot do anything about it? It's more a blessing than anything that we produce highly rated manufactured products. We get up early; we stay up late, adjusting and improving. We perfect details through a magnifying glass, so to speak, leaving no stone unturned. It is the way we are.

For over a quarter of a century, we Marmorin people have espoused an outlook which centres on family, care and persistence. Was it this very Polish pride that was the reason behind the Western European embracement of our industries? Whatever the reasons behind of our success, we have held our own. Even by the demanding standards of the Italian and German market. We are a small Polish company reaching for the highest, furthest and for the greatest scope. We are a business that has matured..

At fairs, exhibitions & presentations etc, we faced the competition and we learned.

In the market place, it is not the business which makes the decisions, but the customer and we have known this always to be true.

Whatever the customer envisages, dreams and searches for, we are in the business to present it to them. From Design, Endurance, Quality, Individuality, Functionality & Trends. (And the next door neighbour's opinions, of course).

HISTORY



Wschowa

Knowledge, experience and the ability of responding to the customers' needs constitutes the wealth behind which a prosaic sink hides.

Marmorin was established in 1985. The first years were dedicated to manufacturing countertops from the so-called artificial marble and allowed to begin experimental production. First, our bathroom sinks, then kitchen sinks and shower trays became products meeting the strictest standards and the most demanding requirements of the customers mainly from Western Europe; during the 80s and 90s almost all our products were exported to the markets of the west.

Our solutions offer was expanded by the solid surface technology – material used for production of bathroom sinks and shower trays which is highly appreciated in Europe and the US due to the unique features: freedom and precision of the form, colours, luxurious appearance etc. This convinces and teases the most demanding users.

In 1998 our bathroom sink was awarded with the Budma medal. The prestigious distinction contributed to acquiring new sales markets and thus, new orders. In order to meet the demand, Marmorin expanded its headquarters by a spacious factory in Wschowa. Implementing the ISO 9001 quality assurance system was a must while being eco-friendly, we also implemented the environmental management system, i.e. ISO 14001.

The qualifications of our staff as well as the state-of-the-art technology park allow to quickly introduce innovative designs and permanent high quality of products.

We consider the above to be our main advantage.

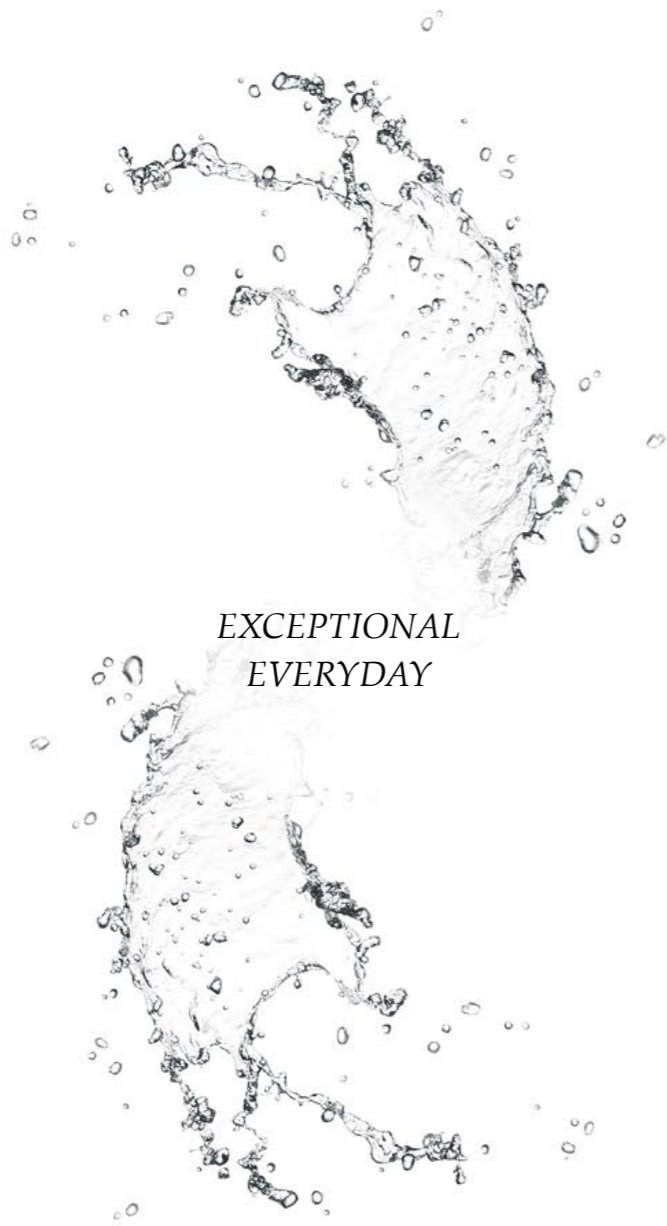

*EXCEPTIONAL
EVERYDAY*

*DESIGN AWAKENS SENSES.
PLEASURE OF TOUCH.
VIEW OF A PERFECT SHAPE.
EVERYDAY SATISFACTION.
CONTINUOUS CONTACT WITH PERFECTION.
WITHIN ARM'S REACH. LITERALLY.*





PIA 600

Index: 570 060 020 xx x gelcoat® material
 Index: 570 060 040 xx x gelcoat® mat material
 dimensions: 620 / 361 / 125 mm



PIA 600 WALL-STANDING

Index: 571 060 020 xx x gelcoat® material
 Index: 571 060 040 xx x gelcoat® mat material
 dimensions: 600 / 410 / 126 mm



PIA 700

Index: 572 070 020 xx x gelcoat® material
 Index: 572 070 040 xx x gelcoat® mat material
 dimensions: 720 / 361 / 125 mm



PIA 900

Index: 573 090 020 xx x gelcoat® material
 Index: 573 090 040 xx x gelcoat® mat material
 dimensions: 900 / 361 / 125 mm



PIA BATHTUB

Index: 588 160 020 xx x gelcoat® material
 Index: 588 160 040 xx x gelcoat® mat material
 dimensions: 1607 / 653 / 650 mm



PALERA

Index: 585 060 020 xx x gelcoat® material
 Index: 585 060 040 xx x gelcoat® mat material
 dimensions: 596 / 277 / 268 mm



**NOEMI**

Index: 560 040 020 xx x gelcoat® material
 Index: 560 040 040 xx x gelcoat® mat material
 dimensions: 400 / 400 / 850 mm

**FEBE**

Index: 460 090 020 xx x gelcoat® material
 Index: 460 090 040 xx x gelcoat® mat material
 dimensions: 900 / 360 / 850 mm

**REA STANDING**

Index: 211 040 020 xx x gelcoat® material
 Index: 211 040 040 xx x gelcoat® mat material
 dimensions: 400 / 400 / 855 mm

**ERATO**

Index: 370 050 020 xx x gelcoat® material
 Index: 370 050 040 xx x gelcoat® mat material
 dimensions: 490 / 495 / 885 mm

**WAVE**

Index: 475 040 020 xx x gelcoat® material
 Index: 475 040 040 xx x gelcoat® mat material
 dimensions: 400 / 400 / 880 mm

**WAVER**

Index: 470 040 020 xx x gelcoat® material
 Index: 470 040 040 xx x gelcoat® mat material
 dimensions: 400 / 400 / 875 mm







TYTAN
Design: Marmorin Design Studio



TYTAN
Design: Marmorin Design Studio



TYTAN WASHBASIN

Index: 586 550 020 xx x gelcoat® material
Index: 586 550 040 xx x gelcoat® mat material
dimensions: 620 / 460 / 112 mm



STANDING ENCLOSURE FOR TYTAN WASHBASIN

Index: 586 080 020 xx gelcoat® material
Index: 586 080 040 xx gelcoat® mat material
dimensions: 514 / 411 / 800 mm



TYTAN BATHTUB

Index: 587 180 020 xx x gelcoat® material
Index: 587 180 040 xx x gelcoat® mat material
dimensions: 1790 / 890 / 623 mm



TYTAN ENCLOSURE

Index: 587 060 020 xx gelcoat® material
Index: 587 060 040 xx gelcoat® mat material
dimensions: 498 / 115 / 613 mm



VALA
Design: Monika Elikowska-Opala, Wojciech Opala



VALA
Index: 510 071 020 xx x gelcoat® material
Index: 510 071 040 xx x gelcoat® mat material
dimensions: 705 / 505 / 82 mm



TONI
Index: 495 060 020 xx x gelcoat® material
Index: 495 060 040 xx x gelcoat® mat material
dimensions: 600 / 400 / 138 mm

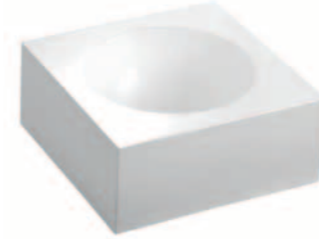

REA

Index: 201 040 020 xx x gelcoat® material
 Index: 201 040 040 xx x gelcoat® mat material
 dimensions: 400 / 400 / 165 mm



PERLA

Index: 360 040 020 xx x gelcoat® material
 Index: 360 040 040 xx x gelcoat® mat material
 dimensions: 400 / 400 / 264 mm



LIVA 500 WASHBASIN

Index: 556 048 020 xx x gelcoat® material
 Index: 556 048 040 xx x gelcoat® mat material
 dimensions: 486 / 320 / 137 mm



LIVA 600 WASHBASIN

Index: 556 060 020 xx x gelcoat® material
 Index: 556 060 040 xx x gelcoat® mat material
 dimensions: 600 / 350 / 137 mm



LIVA BATHTUB

Index: 555 170 020 xx x gelcoat® material
 Index: 555 170 040 xx x gelcoat® mat material
 dimensions: 1700 / 761 / 600 mm



TATOO WHITE PLATE

Index: 111 071 020 xx x gelcoat® material
Index: 111 071 040 xx x gelcoat® mat material
dimensions: 705 / 504 / 68 mm



TATOO BLACK PLATE

Index: 112 071 020 xx x gelcoat® material
dimensions: 705 / 504 / 68 mm

Different colour of plate possible (additional charges apply)







BALIA WASHBASIN

Index: 591 040 020 xx x gelcoat® material
 Index: 591 040 040 xx x gelcoat® mat material
 dimensions: 400 / 400 / 300 mm



BALIA BATHTUB

Index: 590 120 020 xx x gelcoat® material
 Index: 590 120 040 xx x gelcoat® mat material
 dimensions: 1200 / 1200 / 650 mm



MODICO

Index: 350 060 020 xx x gelcoat® material
 Index: 350 060 040 xx x gelcoat® mat material
 dimensions: 600 / 430 / 145 mm

* 800 mm length also available:
 Index: 350 080 020 xx x gelcoat® material
 Index: 350 080 040 xx x gelcoat® mat material
 dimensions: 800 / 430 / 145 mm



ROSA

Index: 250 060 020 xx x gelcoat® material
 Index: 250 060 040 xx x gelcoat® mat material
 dimensions: 600 / 435 / 110 mm



NOEL 800

Index: 580 080 020 xx x gelcoat® material
 Index: 580 080 040 xx x gelcoat® mat material
 dimensions: 800 / 450 / 112 mm



NOEL 1000

Index: 581 100 020 xx x gelcoat® material
 Index: 581 100 040 xx x gelcoat® mat material
 dimensions: 1000 / 450 / 112 mm



KORE

Index: 490 040 020 xx x gelcoat® material
 Index: 490 040 040 xx x gelcoat® mat material
 dimensions: 400 / 400 / 120 mm



JACOB

Index: 485 039 020 xx x gelcoat® material
 Index: 485 039 040 xx x gelcoat® mat material
 dimensions: 358 / 358 / 247 mm



NOEL 1200

Index: 582 120 020 xx x gelcoat® material
 Index: 582 120 040 xx x gelcoat® mat material
 dimensions: 1200 / 450 / 112 mm



NOEL DUET

Index: 583 120 020 xx x gelcoat® material
 Index: 583 120 040 xx x gelcoat® mat material
 dimensions: 1200 / 450 / 112 mm



DUDU

Index: 480 084 020 xx x gelcoat® material
 Index: 480 084 040 xx x gelcoat® mat material
 dimensions: 837 / 420 / 449 mm



LAVINIA

Index: 120 089 022 xx x gelcoat® material
 Index: 120 089 042 xx x gelcoat® mat material
 dimensions: 890 / 515 / 150 mm





TALIA 60

Index: 270 060 022 xx x gelcoat® material
 Index: 270 060 042 xx x gelcoat® mat material
 dimensions: 600 / 310 / 140 mm



TALIA 90 L/R

Index: 270 090 722 xx x gelcoat® material
 Index: 270 090 742 xx x gelcoat® mat material
 dimensions: 900 / 310 / 140 mm

* Also available in the right-hand side version:
 Index: 270 090 922 xx x gelcoat® material
 Index: 270 090 942 xx x gelcoat® mat material
 dimensions: 900 / 310 / 140 mm



TALIA 120

Index: 270 120 022 xx x gelcoat® material
 Index: 270 120 042 xx x gelcoat® mat material
 dimensions: 1204 / 310 / 140 mm



DUNA

Index: 190 060 020 xx x gelcoat® material
 Index: 190 060 040 xx x gelcoat® mat material
 dimensions: 600 / 450 / 120 mm



DIONE

Index: 505 070 020 xx x gelcoat® material
 Index: 505 070 040 xx x gelcoat® mat material
 dimensions: 700 / 450 / 115 mm



IVA

Index: 220 060 022 xx x gelcoat® material
 Index: 220 060 042 xx x gelcoat® mat material
 dimensions: 600 / 390 / 157 mm





CETI

Index: 180 045 020 xx x gelcoat® material
 Index: 180 045 040 xx x gelcoat® mat material
 dimensions: 450 / 480 / 150 mm



CETO 60

Index: 170 060 022 xx x gelcoat® material
 Index: 170 060 042 xx x gelcoat® mat material
 dimensions: 600 / 430 / 150 mm



CETO 80

Index: 170 080 022 xx x gelcoat® material
 Index: 170 080 042 xx x gelcoat® mat material
 dimensions: 800 / 430 / 150 mm



CETO 90

Index: 170 090 022 xx x gelcoat® material
 Index: 170 090 042 xx x gelcoat® mat material
 dimensions: 900 / 550 / 150 mm



CETO 130

Index: 170 130 022 xx x gelcoat® material
 Index: 170 130 042 xx x gelcoat® mat material
 dimensions: 1300 / 550 / 150 mm



ARGO

Index: 290 100 022 xx x gelcoat® material
 Index: 290 100 042 xx x gelcoat® mat material
 dimensions: 1000 / 500 / 140 mm



PAMONA 75

Index: 320 075 022 xx x gelcoat® material
 Index: 320 075 042 xx x gelcoat® mat material
 dimensions: 750 / 477 / 175 mm



PAMONA 121

Index: 320 121 022 xx x gelcoat® material
 Index: 320 121 042 xx x gelcoat® mat material
 dimensions: 1210 / 480 / 174 mm



CARME 98

Index: 260 098 020 xx x gelcoat® material
 Index: 260 098 040 xx x gelcoat® mat material
 dimensions: 980 / 550 / 145 mm



CARME 130

Index: 260 130 020 xx x gelcoat® material
 Index: 260 130 040 xx x gelcoat® mat material
 dimensions: 1300 / 550 / 150 mm



ATAMI

Index: 465 100 020 xx x gelcoat® material
 Index: 465 100 040 xx x gelcoat® mat material
 dimensions: 1000 / 387 / 955 mm



UNI

Index: 550 085 022 xx x gelcoat® material
 Index: 550 085 042 xx x gelcoat® mat material
 dimensions: 850 / 600 / 120 mm





UNI
Design: Anna Dul



FAMA BATHTUB, DELIA WASHBASIN
Design: Marmorin Design Studio



FAMA (MODEL WITHOUT OVERFLOW)
Design: Marmorin Design Studio



FAMA
Design: Marmorin Design Studio



DISA 50

Index: 130 050 020 xx x gelcoat® material
Index: 130 050 040 xx x gelcoat® mat material
dimensions: 500 / 480 / 150 mm



DISA 60

Index: 130 060 020 xx x gelcoat® material
Index: 130 060 040 xx x gelcoat® mat material
dimensions: 600 / 520 / 150 mm



ATRIA

Index: 150 065 020 xx x gelcoat® material
Index: 150 065 040 xx x gelcoat® mat material
dimensions: 650 / 520 / 150 mm



DELIA

Index: 140 063 021 xx x gelcoat® material
Index: 140 063 041 xx x gelcoat® mat material
dimensions: 630 / 465 / 180 mm



FAMA BATHTUB

Index: 566 173 020 xx x gelcoat® material
dimensions: 1700 / 762 / 560 mm



FAMA LEG

Index: 566 016 01 (white)
Index: 566 016 02 (black)
dimensions: 155 / 135 / 310 mm



ELARA 2



ELARA 1

Index: 390 040 020 xx x gelcoat® material
Index: 390 040 040 xx x gelcoat® mat material
dimensions: 400 / 200 / 100 mm



ELARA 2

Index: 400 040 020 xx x gelcoat® material
Index: 400 040 040 xx x gelcoat® mat material
dimensions: 400 / 200 / 100 mm



ELARA 3

Index: 410 040 020 xx x gelcoat® material
Index: 410 040 040 xx x gelcoat® mat material
dimensions: 400 / 200 / 100 mm



ELARA 4

Index: 420 040 020 xx x gelcoat® material
Index: 420 040 040 xx x gelcoat® mat material
dimensions: 400 / 200 / 100 mm



MOIRA BIS 60

Index: 280 060 022 xx x gelcoat® material
Index: 280 060 042 xx x gelcoat® mat material
dimensions: 600 / 500 / 145 mm



MOIRA BIS 70

Index: 280 070 022 xx x gelcoat® material
Index: 280 070 042 xx x gelcoat® mat material
dimensions: 700 / 500 / 145 mm



MOIRA BIS 80

Index: 280 080 022 xx x gelcoat® material
Index: 280 080 042 xx x gelcoat® mat material
dimensions: 800 / 500 / 145 mm



MOIRA BIS 90

Index: 280 090 022 xx x gelcoat® material
Index: 280 090 042 xx x gelcoat® mat material
dimensions: 900 / 500 / 145 mm



MOIRA BIS 120

Index: 280 120 022 xx x gelcoat® material
Index: 280 120 042 xx x gelcoat® mat material
dimensions: 1200 / 500 / 145 mm



MOIRA BIS 120 DUET

Index: 280 120 222 xx x gelcoat® material
Index: 280 120 242 xx x gelcoat® mat material
dimensions: 1200 / 500 / 145 mm



LARISSA 60

Index: 300 060 022 xx x gelcoat® material
 Index: 300 060 042 xx x gelcoat® mat material
 dimensions: 600 / 480 / 147 mm



LARISSA 90 L/R

Index: 300 090 722 xx x gelcoat® material
 Index: 300 090 742 xx x gelcoat® mat material
 dimensions: 900 / 480 / 150 mm

* Also available in the right-hand side version:
 Index: 300 090 922 xx x gelcoat® material
 Index: 300 090 942 xx x gelcoat® mat material
 dimensions: 900 / 480 / 150 mm



LARISSA 120

Index: 300 120 022 xx x gelcoat® material
 Index: 300 120 042 xx x gelcoat® mat material
 dimensions: 1200 / 480 / 150 mm



LARISSA HOTEL

Index: 301 120 022 xx x gelcoat® material
 Index: 301 120 042 xx x gelcoat® mat material
 dimensions: 1200 / 480 / 145 mm



HALE

Index: 340 180 021 xx x gelcoat® material
 Index: 340 180 041 xx x gelcoat® mat material
 dimensions: 1800 / 480 / 200 mm



ONDA

Index: 330 120 022 xx x gelcoat® material
 Index: 330 120 042 xx x gelcoat® mat material
 dimensions: 1200 / 500 / 240 mm

top
design
award
2010



LA DONNA
Design: Marmorin Design Studio



LA DONNA WASHBASIN

Index: 565 070 020 xx x gelcoat® material
Index: 565 070 040 xx x gelcoat® mat material
dimension: 700 / 460 / 112 mm



LA DONNA LEG

Index: 565 078 020 xx gelcoat® material
Index: 565 078 040 xx gelcoat® mat material
dimension: 200 / 190 / 780 mm



ROSA 90 SQUARE SHOWER TRAY

Index: 250 090 2xx gelcoat® material
Index: 250 090 4xx gelcoat® mat material
dimension: 900 / 900 / 60 mm

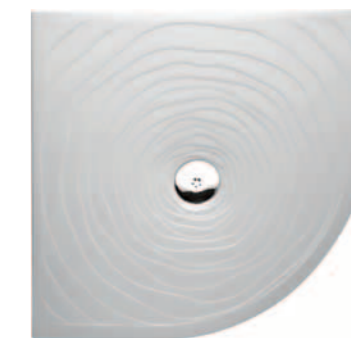

ROSA 90 ROUND SHOWER TRAY

Index: 255 090 2xx gelcoat® material
Index: 255 090 4xx gelcoat® mat material
dimension: 900 / 900 / 60 mm / r 550



MODICO I RECTANGULAR SHOWER TRAY

Index: 269 129 2xx gelcoat® material
Index: 269 129 4xx gelcoat® mat material
dimension: 1200 / 900 / 60 mm



MODICO I RECTANGULAR SHOWER TRAY

Index: 269 128 2xx gelcoat® material
Index: 269 128 4xx gelcoat® mat material
dimension: 1200 / 800 / 60 mm



MODICO II RECTANGULAR SHOWER TRAY

Index: 279 129 2xx gelcoat® material
Index: 279 129 4xx gelcoat® mat material
dimension: 1200 / 900 / 60 mm



CETI 80 SQUARE SHOWER TRAY

Index: 180 080 2xx gelcoat® material
Index: 180 080 4xx gelcoat® mat material
dimension: 800 / 800 / 55 mm



CETI 90 SQUARE SHOWER TRAY

Index: 180 090 2xx gelcoat® material
 Index: 180 090 4xx gelcoat® mat material
 dimension: 900 / 900 / 55 mm



CETI 80 ROUND SHOWER TRAY

Index: 185 080 2xx gelcoat® material
 Index: 185 080 4xx gelcoat® mat material
 dimension: 800 / 800 / 45 mm / r 480



CETI 90 ROUND SHOWER TRAY

Index: 185 090 2xx gelcoat® material
 Index: 185 090 4xx gelcoat® mat material
 dimension: 900 / 900 / 55 mm / r 480



OTERO 80 ROUND SHOWER TRAY

Index: 285 080 2xx gelcoat® material
 Index: 285 080 4xx gelcoat® mat material
 dimension: 800 / 800 / 45 mm / r 550



OTERO 90 ROUND SHOWER TRAY

Index: 285 090 2xx gelcoat® material
 Index: 285 090 4xx gelcoat® mat material
 dimension: 900 / 900 / 45 mm / r 550



DIONE SHOWER TRAY

Index: 490 090 2xx gelcoat® material
 Index: 490 090 4xx gelcoat® mat material
 dimension: 900 / 900 / 100 mm

cutting template

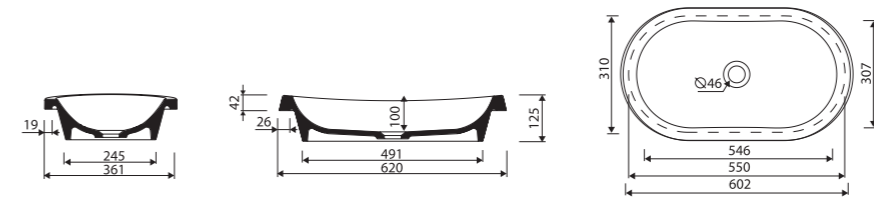

recommended mounting method:
 countertop, inset washbasin

without tap opening,
 without overflow

page 9

PIA 600

index:
 gelcoat® material: 570 060 020 xx x
 gelcoat® mat material: 570 060 040 xx x



LENGTH	WIDTH	HEIGHT	mm
620	361	125	

page 9

PIA 600 WALL-STANDING

index:
 gelcoat® material: 571 060 020 xx x
 gelcoat® mat material: 571 060 040 xx x

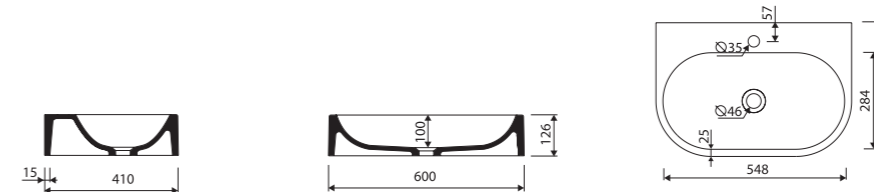

recommended mounting method:
 countertop, wall-mounted

with tap opening,
 without overflow



LENGTH	WIDTH	HEIGHT	mm
600	410	126	

cutting template

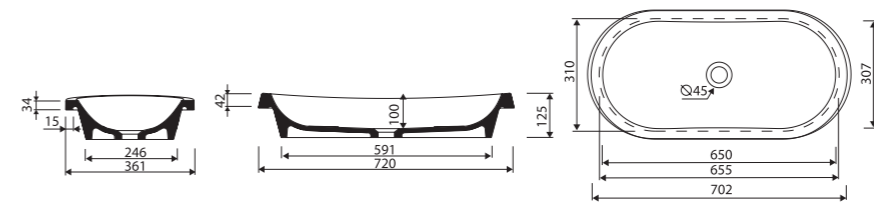

recommended mounting method:
 countertop, inset washbasin

without tap opening,
 without overflow

page 9

PIA 700

index:
 gelcoat® material: 572 070 020 xx x
 gelcoat® mat material: 572 070 040 xx x



LENGTH	WIDTH	HEIGHT	mm
720	361	125	

cutting template

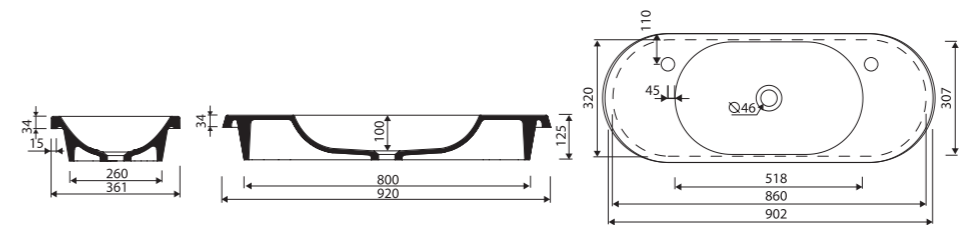

recommended mounting method: upon customer's order we can provide an opening in the counter for tap on the left or right side, without overflow

page 9

PIA 900

index:
 gelcoat® material: 573 090 020 xx x
 gelcoat® mat material: 573 090 040 xx x



LENGTH	WIDTH	HEIGHT	mm
920	361	125	

PIA BATHTUB

page 9

index:
gelcoat® material: 588 160 020 xx x
gelcoat® mat material: 588 160 040 xx x

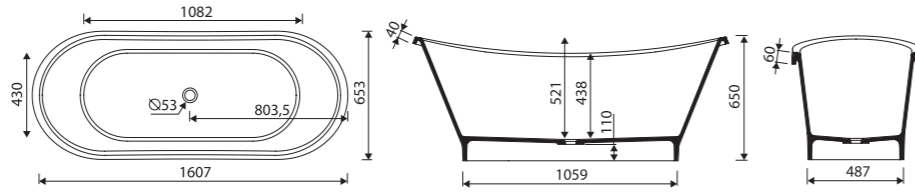

LENGTH 1607 WIDTH 653 HEIGHT 650 mm

without tap opening,
without overflow

recommended mounting method:
free-standing

PALERA

page 9

index:
gelcoat® material: 585 060 020 xx x
gelcoat® mat material: 585 060 040 xx x

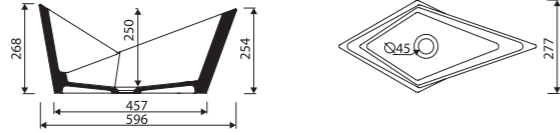

LENGTH 596 WIDTH 277 HEIGHT 268 mm

without tap opening,
without overflow

recommended mounting method:
countertop

NOEMI

page 13

index:
gelcoat® material: 560 040 020 xx x
gelcoat® mat material: 560 040 040 xx x

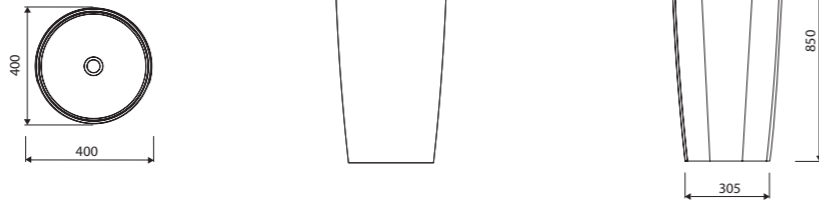

LENGTH 400 WIDTH 400 HEIGHT 850 mm

without tap opening,
without overflow

recommended mounting method:
wall-standing

FEBE

page 13

index:
gelcoat® material: 460 090 020 xx x
gelcoat® mat material: 460 090 040 xx x

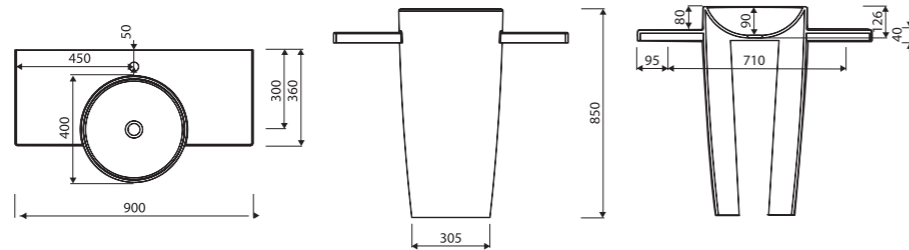

LENGTH 900 WIDTH 360 HEIGHT 850 mm

with or without tap opening,
without overflow

recommended mounting method:
wall-standing

REA STANDING

page 13

index:
gelcoat® material: 211 040 020 xx x
gelcoat® mat material: 211 040 040 xx x

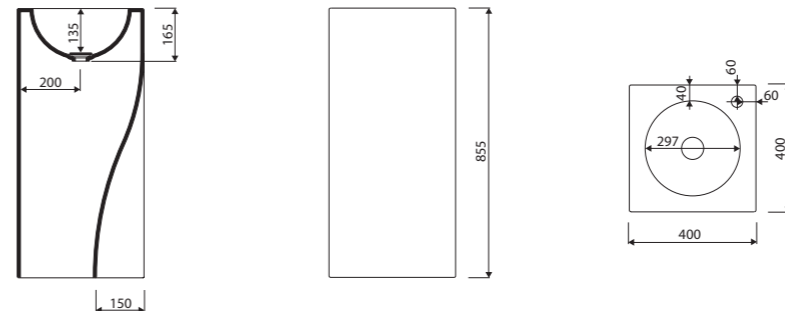

recommended mounting method:
wall-standing

with or without tap opening,
without overflow

LENGTH 400 WIDTH 400 HEIGHT 855 mm

ERATO

page 13

index:
gelcoat® material: 370 050 020 xx x
gelcoat® mat material: 370 050 040 xx x

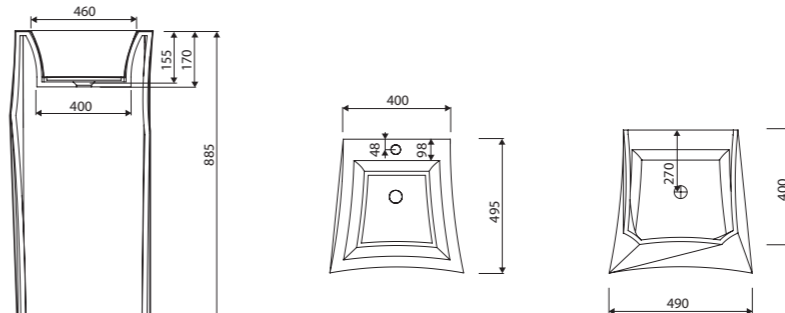

recommended mounting method:
wall-standing

with or without tap opening,
without overflow

LENGTH 490 WIDTH 495 HEIGHT 885 mm

WAVE

page 13

index:
gelcoat® material: 475 040 020 xx x
gelcoat® mat material: 475 040 040 xx x

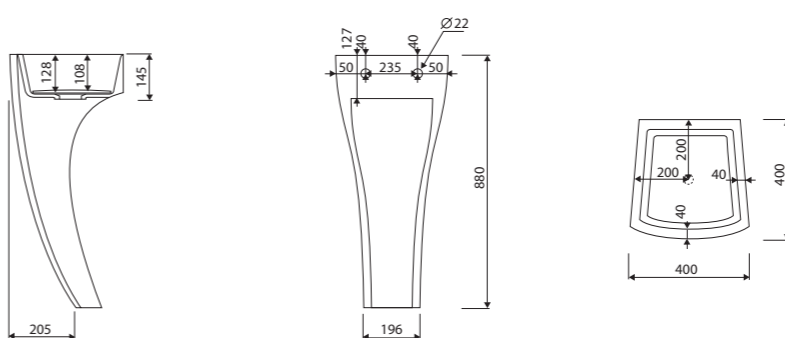

recommended mounting method:
wall-standing

without tap opening,
without overflow

LENGTH 400 WIDTH 400 HEIGHT 880 mm

WAVER

page 13

index:
gelcoat® material: 470 040 020 xx x
gelcoat® mat material: 470 040 040 xx x

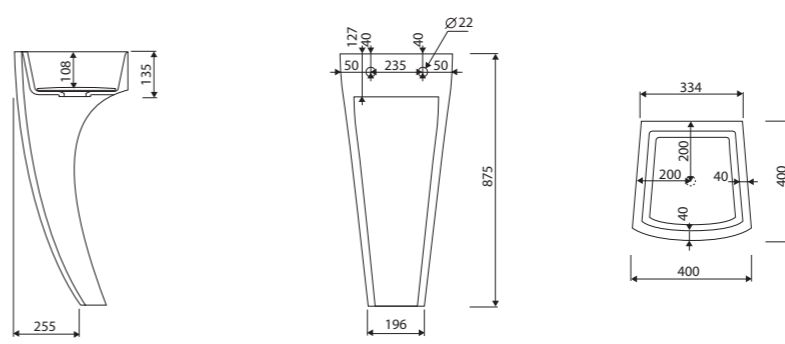

recommended mounting method:
wall-standing

without tap opening,
without overflow

LENGTH 400 WIDTH 400 HEIGHT 875 mm

TYTAN WASHBASIN

page 18

cutting template

index:
gelcoat® material: 586 550 020 xx x
gelcoat® mat material: 586 550 040 xx x

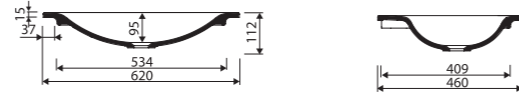
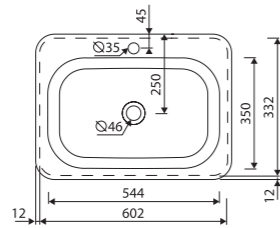

LENGTH 620 WIDTH 460 HEIGHT 112 mm

upon customer's order with or without tap opening, without overflow

recommended mounting method: countertop, kompatybilna ze stojącą zabudową do umywalki

STANDING ENCLOSURE FOR TYTAN WASHBASIN

page 18

index:
gelcoat® material: 586 080 020 xx
gelcoat® mat material: 586 080 040 xx

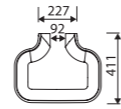
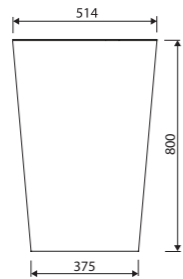

LENGTH 514 WIDTH 411 HEIGHT 800 mm

recommended mounting method: wall-standing

TYTAN BATHTUB

page 19

index:
gelcoat® material: 587 180 020 xx x
gelcoat® mat material: 587 180 040 xx x

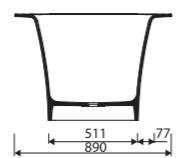
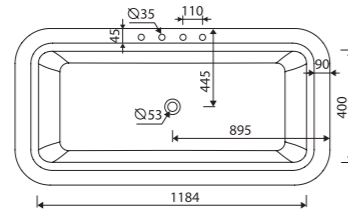
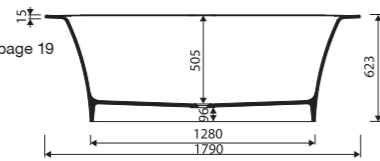

TYTAN ENCLOSURE

index:
gelcoat® material: 587 060 020 xx
gelcoat® mat material: 587 060 040 xx
LENGTH 498 WIDTH 115 HEIGHT 613 mm

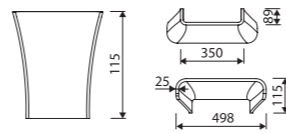

LENGTH 1790 WIDTH 890 HEIGHT 623 mm

upon customer's order with or without tap opening, with or without overflow

recommended mounting method: free-standing

VALA

page 20

index:
gelcoat® material: 510 071 020 xx x
gelcoat® mat material: 510 071 040 xx x

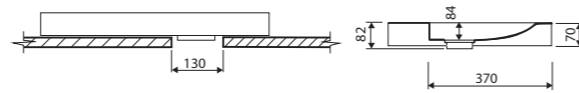
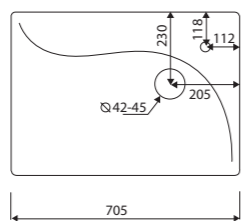

LENGTH 705 WIDTH 505 HEIGHT 82 mm

with or without tap opening, without overflow

recommended mounting method: countertop

TONI

page 20

index:
gelcoat® material: 495 060 020 xx x
gelcoat® mat material: 495 060 040 xx x

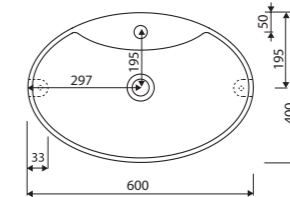
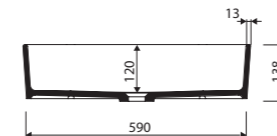
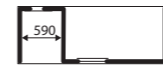

recommended mounting method: countertop

with or without tap opening, without overflow

LENGTH 600 WIDTH 400 HEIGHT 138 mm

STANDING ENCLOSURE FOR TYTAN WASHBASIN

page 18

index:
gelcoat® material: 586 080 020 xx
gelcoat® mat material: 586 080 040 xx

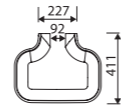
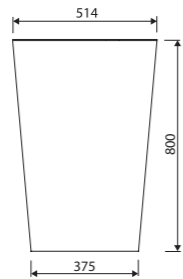

LENGTH 514 WIDTH 411 HEIGHT 800 mm

recommended mounting method: wall-standing

REA

page 23

index:
gelcoat® material: 201 040 020 xx x
gelcoat® mat material: 201 040 040 xx x

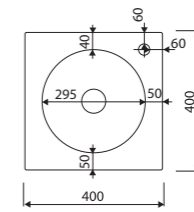
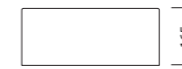
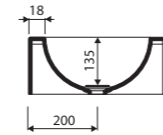
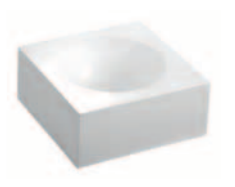

recommended mounting method: countertop, vanity unit

with or without tap opening, without overflow

LENGTH 400 WIDTH 400 HEIGHT 165 mm

TYTAN BATHTUB

page 19

index:
gelcoat® material: 587 180 020 xx x
gelcoat® mat material: 587 180 040 xx x

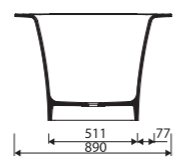
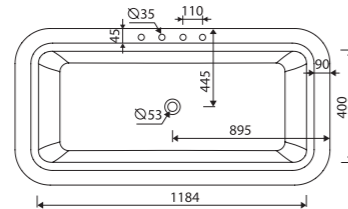
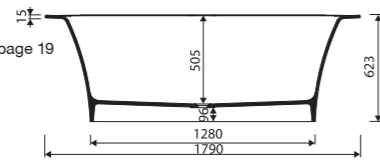

TYTAN ENCLOSURE

index:
gelcoat® material: 587 060 020 xx
gelcoat® mat material: 587 060 040 xx
LENGTH 498 WIDTH 115 HEIGHT 613 mm

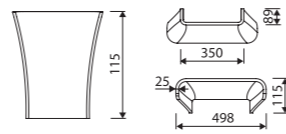

LENGTH 1790 WIDTH 890 HEIGHT 623 mm

upon customer's order with or without tap opening, with or without overflow

recommended mounting method: free-standing

PERLA

page 23

index:
gelcoat® material: 360 040 020 xx x
gelcoat® mat material: 360 040 040 xx x

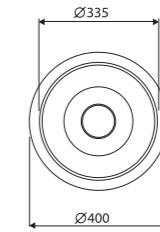
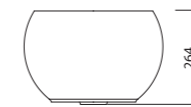
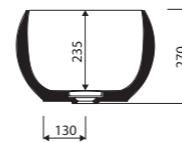

recommended mounting method: countertop

with or without tap opening, without overflow

LENGTH 400 WIDTH 400 HEIGHT 264 mm

VALA

page 20

index:
gelcoat® material: 510 071 020 xx x
gelcoat® mat material: 510 071 040 xx x

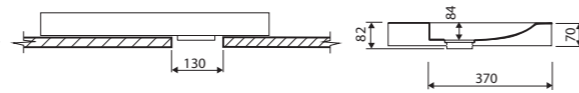
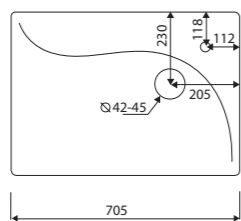

LENGTH 705 WIDTH 505 HEIGHT 82 mm

with or without tap opening, without overflow

recommended mounting method: countertop

LIVA 500 WASHBASIN

page 23

index:
gelcoat® material: 556 048 020 xx x
gelcoat® mat material: 556 048 040 xx x

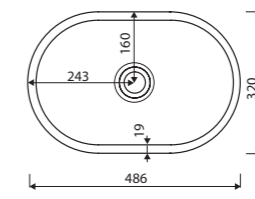
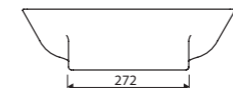
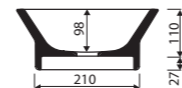

recommended mounting method: countertop

without tap opening, without overflow

LENGTH 486 WIDTH 320 HEIGHT 137 mm

LIVA 600 WASHBASIN

page 23

index:
gelcoat® material: 556 060 020 xx x
gelcoat® mat material: 556 060 040 xx x

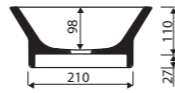
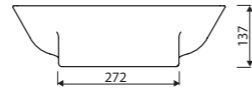
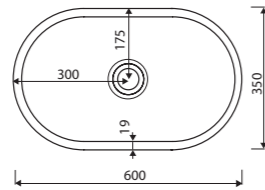

LENGTH 600 WIDTH 350 HEIGHT 137 mm

without tap opening,
without overflow

recommended mounting method:
countertop

LIVA BATHTUB

page 23

index:
gelcoat® material: 555 170 020 xx x
gelcoat® mat material: 555 170 040 xx x

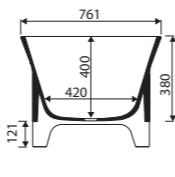
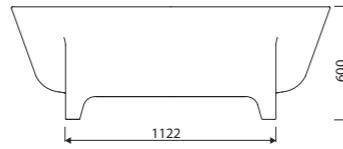
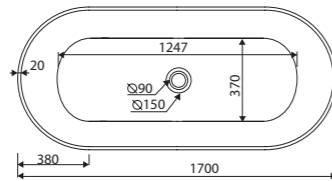

LENGTH 1700 WIDTH 761 HEIGHT 600 mm

without tap opening,
without overflow

recommended mounting method:
free-standing

TATOO

page 25

TATOO BLACK PLATE index:
gelcoat® material: 112 071 020 xx x

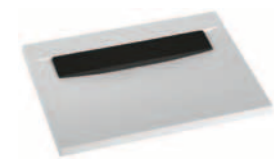

TATOO WHITE PLATE index:
gelcoat® material: 111 071 020 xx x
gelcoat® mat material: 111 071 040 xx x

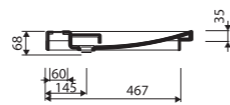
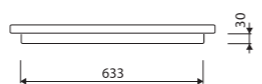
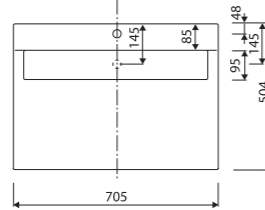

LENGTH 705 WIDTH 504 HEIGHT 68 mm

with or without tap opening,
without overflow

recommended mounting method:
countertop

BALIA WASHBASIN

page 28

index:
gelcoat® material: 591 040 020 xx x
gelcoat® mat material: 591 040 040 xx x

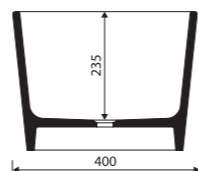
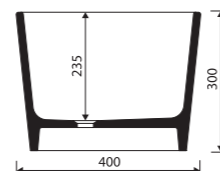
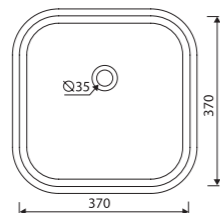

LENGTH 400 WIDTH 400 HEIGHT 300 mm

without tap opening,
without overflow

recommended mounting method:
countertop

BALIA BATHTUB

page 28

index:
gelcoat® material: 590 120 020 xx x
gelcoat® mat material: 590 120 040 xx x

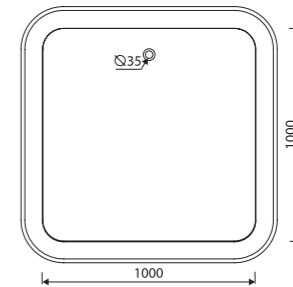
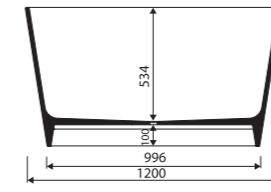
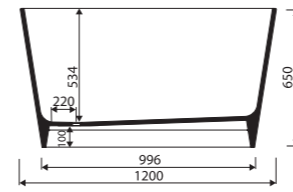

recommended mounting method:
free-standing

without tap opening,
without overflow

LENGTH 1200 WIDTH 1200 HEIGHT 650 mm

NOEL 800

page 28

index:
gelcoat® material: 580 080 020 xx x
gelcoat® mat material: 580 080 040 xx x

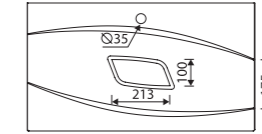
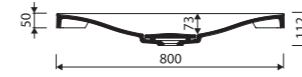
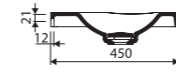

recommended mounting method:
countertop, vanity unit

with or without tap opening,
without overflow

LENGTH 800 WIDTH 450 HEIGHT 112 mm

NOEL 1000

page 28

index:
gelcoat® material: 581 100 020 xx x
gelcoat® mat material: 581 100 040 xx x

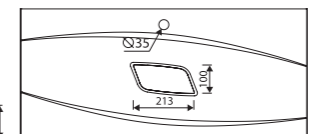
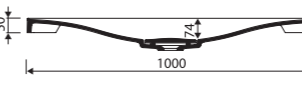
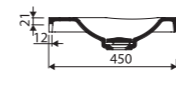

recommended mounting method:
countertop, vanity unit

with or without tap opening,
without overflow

LENGTH 1000 WIDTH 450 HEIGHT 112 mm

NOEL 1200

page 28

index:
gelcoat® material: 582 120 020 xx x
gelcoat® mat material: 582 120 040 xx x

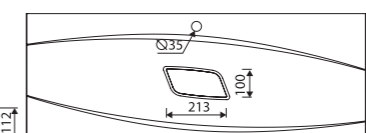
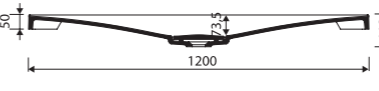
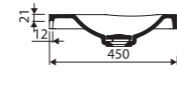

recommended mounting method:
countertop, vanity unit

with or without tap opening,
without overflow

LENGTH 1200 WIDTH 450 HEIGHT 112 mm

NOEL DUET page 28

index:
gelcoat® material: 583 120 220 xx x
gelcoat® mat material: 583 120 240 xx x

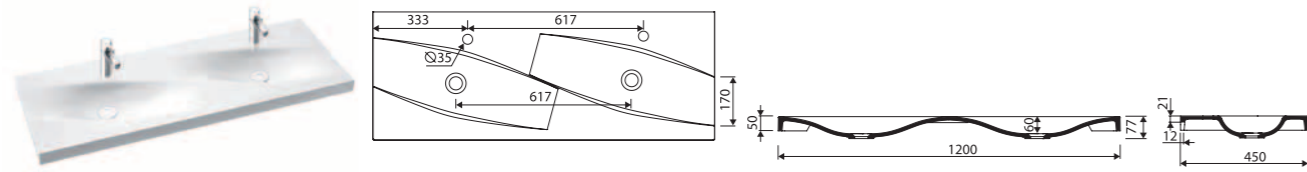

LENGTH 1200
WIDTH 450
HEIGHT 112 mm

with two tap openings or without tap openings, without overflow
recommended mounting method: countertop, vanity unit

MODICO page 29

index:
gelcoat® material: 350 060 020 xx x
gelcoat® mat material: 350 060 040 xx x

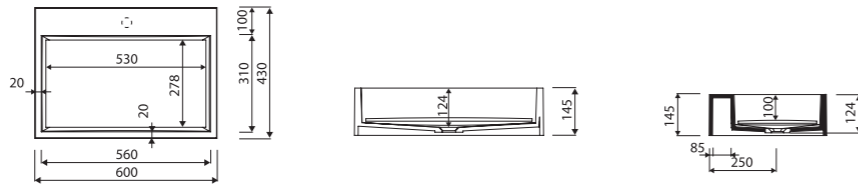

LENGTH 600
WIDTH 430
HEIGHT 145 mm

with or without tap opening, without overflow
recommended mounting method: countertop, vanity unit

* 800 mm length also available:
index:
gelcoat® material: 350 080 020 xx x
gelcoat® mat material: 350 080 040 xx x
LENGTH 800
WIDTH 430
HEIGHT 145 mm

ROSA page 29

index:
gelcoat® material: 250 060 020 xx x
gelcoat® mat material: 250 060 040 xx x

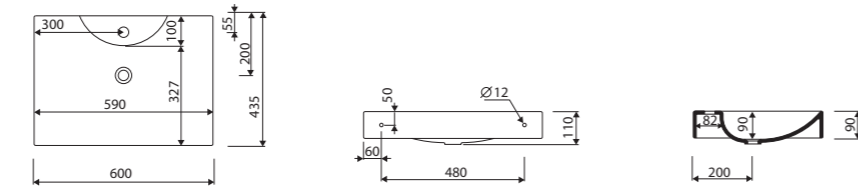

LENGTH 600
WIDTH 435
HEIGHT 110 mm

with tap opening, without overflow
recommended mounting method: countertop, vanity unit, wall-mounted

KORE page 29

index:
gelcoat® material: 490 040 020 xx x
gelcoat® mat material: 490 040 040 xx x

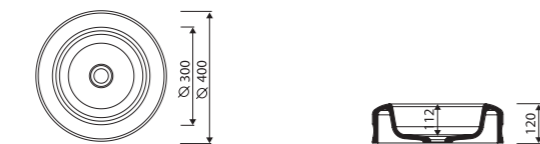

LENGTH 400
WIDTH 400
HEIGHT 120 mm

without tap opening, without overflow
recommended mounting method: countertop

JACOB page 29

index:
gelcoat® material: 485 039 020 xx x
gelcoat® mat material: 485 039 040 xx x

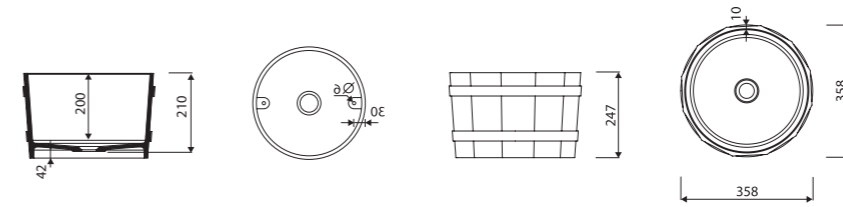

recommended mounting method: countertop

without tap opening, without overflow

LENGTH 358
WIDTH 358
HEIGHT 247 mm

DUDU page 29

index:
gelcoat® material: 480 084 020 xx x
gelcoat® mat material: 480 084 040 xx x

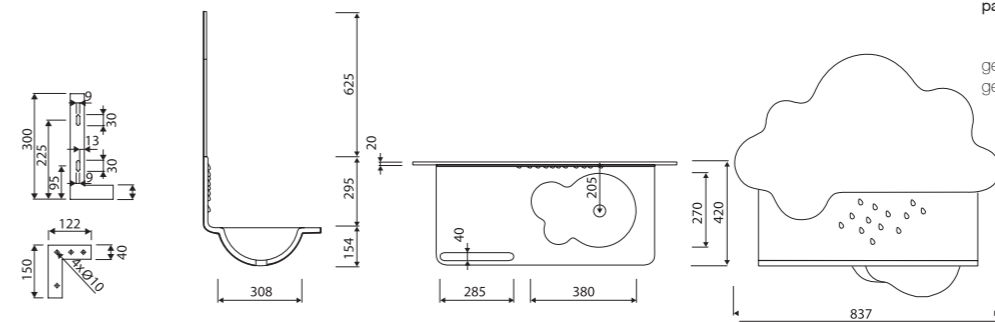

mounted on the brackets

recommended mounting method: wall-mounted

with or without tap opening, without overflow

LENGTH 837
WIDTH 420
HEIGHT 449 mm

LAVINIA page 29

index:
gelcoat® material: 120 089 022 xx x
gelcoat® mat material: 120 089 042 xx x

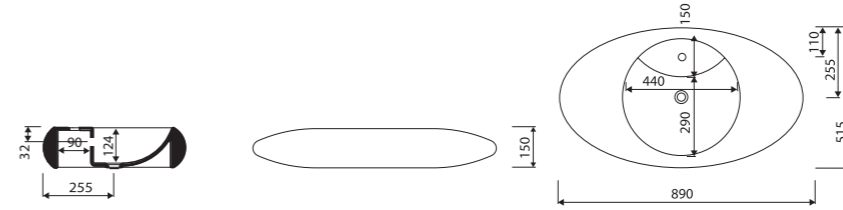

recommended mounting method: countertop

with or without tap opening, with or without overflow

LENGTH 890
WIDTH 515
HEIGHT 150 mm

TALIA 90 L/R

page 32

TALIA 90 L index:
gelcoat® material: 270 090 722 xx x
gelcoat® mat material: 270 090 742 xx x



LENGTH 900
WIDTH 310
HEIGHT 140 mm

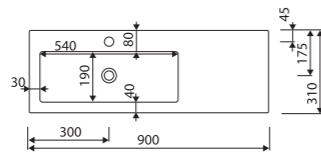

with or without tap opening,
with or without overflow



recommended mounting method:
countertop, vanity unit

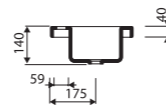

* Also available in the right-hand side version:
TALIA 90 R index:
gelcoat® material: 270 090 922 xx x
gelcoat® mat material: 270 090 942 xx x

IVA

page 32

index:
gelcoat® material: 220 060 022 xx x
gelcoat® mat material: 220 060 042 xx x



LENGTH 600
WIDTH 390
HEIGHT 157 mm

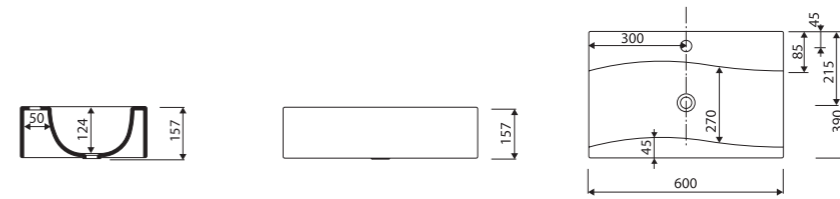

recommended mounting method:
countertop, vanity unit

with or without tap opening,
with overflow

TALIA 120

page 32

index:
gelcoat® material: 270 120 022 xx x
gelcoat® mat material: 270 120 042 xx x



LENGTH 1204
WIDTH 310
HEIGHT 140 mm

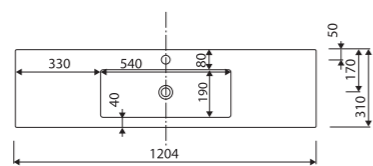

with or without tap opening,
with or without overflow



recommended mounting method:
countertop, vanity unit

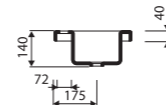

CETI

page 35

index:
gelcoat® material: 180 045 020 xx x
gelcoat® mat material: 180 045 040 xx x



LENGTH 450
WIDTH 480
HEIGHT 150 mm

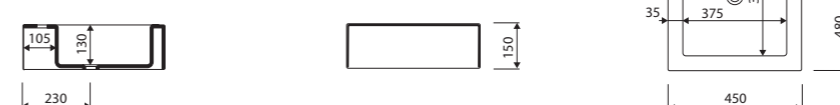

recommended mounting method:
countertop, vanity unit

with or without tap opening,
without overflow

DUNA

page 32

index:
gelcoat® material: 190 060 020 xx x
gelcoat® mat material: 190 060 040 xx x



LENGTH 600
WIDTH 450
HEIGHT 120 mm

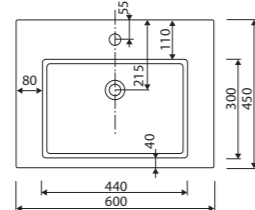

with or without tap opening,
without overflow



recommended mounting method:
countertop, vanity unit

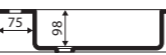

CETO 60

page 35

index:
gelcoat® material: 170 060 022 xx x
gelcoat® mat material: 170 060 042 xx x



LENGTH 600
WIDTH 430
HEIGHT 150 mm

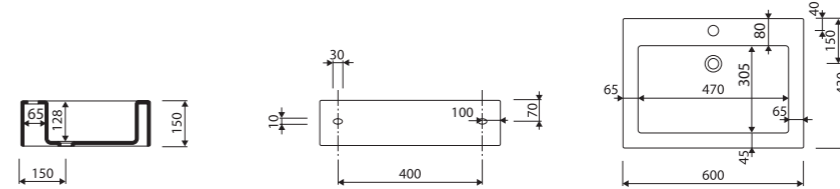

recommended mounting method:
countertop, vanity unit, wall-mounted

with or without tap opening,
with overflow

DIONE

page 32

index:
gelcoat® material: 505 070 020 xx x
gelcoat® mat material: 505 070 040 xx x



LENGTH 700
WIDTH 450
HEIGHT 115 mm

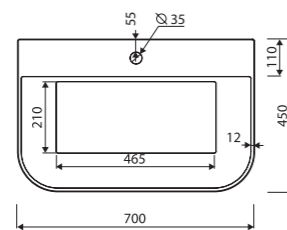

with or without tap opening,
without overflow

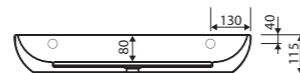

recommended mounting method:
countertop, wall-mounted



CETO 80

page 35

index:
gelcoat® material: 170 080 022 xx x
gelcoat® mat material: 170 080 042 xx x



LENGTH 800
WIDTH 430
HEIGHT 150 mm

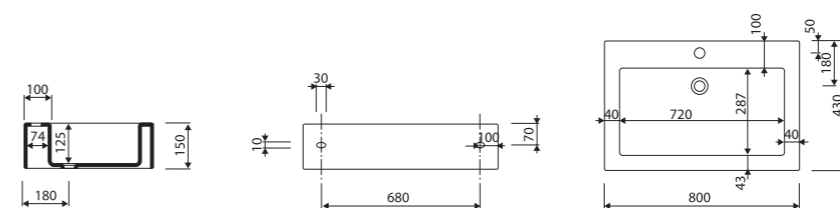

recommended mounting method:
countertop, vanity unit

with or without tap opening,
with overflow

CETO 90

page 35

index:
gelcoat® material: 170 090 022 xx x
gelcoat® mat material: 170 090 042 xx x

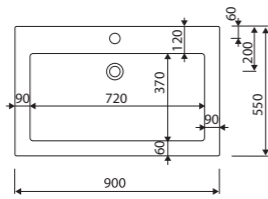

with or without tap opening,
with overflow

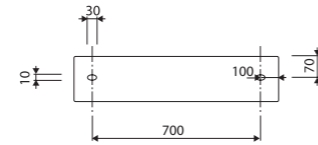

recommended mounting method:
countertop, vanity unit

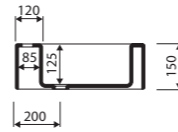

LENGTH 900
WIDTH 550
HEIGHT 150 mm

CETO 130

page 35

index:
gelcoat® material: 170 130 022 xx x
gelcoat® mat material: 170 130 042 xx x

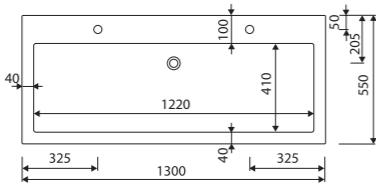

with two tap openings or without openings,
with overflow

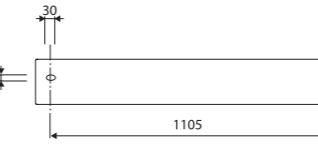

recommended mounting method:
countertop

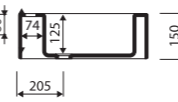

LENGTH 1300
WIDTH 550
HEIGHT 150 mm

ARGO

page 35

index:
gelcoat® material: 290 100 022 xx x
gelcoat® mat material: 290 100 042 xx x

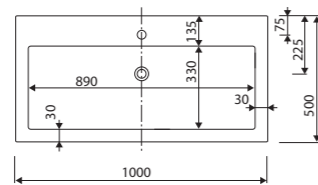

with or without tap opening,
with or without overflow

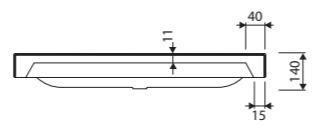

recommended mounting method:
countertop, vanity unit

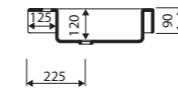

LENGTH 1000
WIDTH 500
HEIGHT 140 mm

PAMONA 75

page 37

index:
gelcoat® material: 320 075 022 xx x
gelcoat® mat material: 320 075 042 xx x

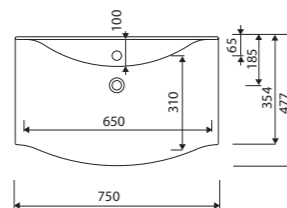

with or without tap opening,
with overflow



recommended mounting method:
countertop, vanity unit

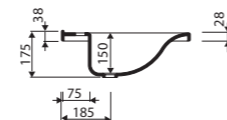

LENGTH 750
WIDTH 477
HEIGHT 175 mm

PAMONA 121

page 37

index:
gelcoat® material: 320 121 022 xx x
gelcoat® mat material: 320 121 042 xx x

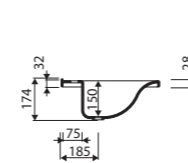

recommended mounting method:
countertop, vanity unit

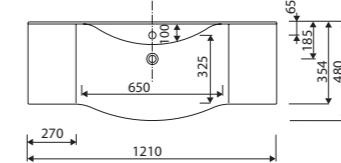

with or without tap opening,
with overflow

LENGTH 1210
WIDTH 480
HEIGHT 174 mm

CARME 98

page 37

index:
gelcoat® material: 260 098 020 xx x
gelcoat® mat material: 260 098 040 xx x

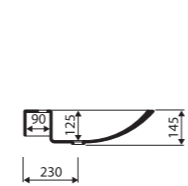

recommended mounting method:
countertop, vanity unit

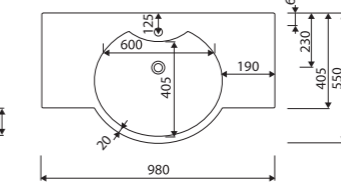
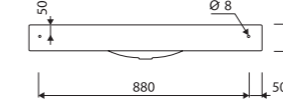

with tap opening,
with or without overflow

LENGTH 980
WIDTH 550
HEIGHT 145 mm

CARME 130

page 37

index:
gelcoat® material: 260 130 020 xx x
gelcoat® mat material: 260 130 040 xx x

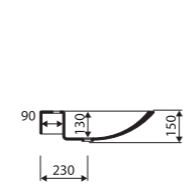

recommended mounting method:
countertop, vanity unit

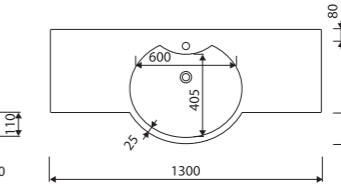
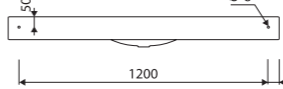

with tap opening,
with or without overflow

LENGTH 1300
WIDTH 550
HEIGHT 150 mm

ATAMI

page 37

index:
gelcoat® material: 465 100 020 xx x
gelcoat® mat material: 465 100 040 xx x

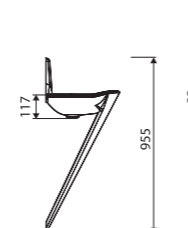

recommended mounting method:
wall-mounted

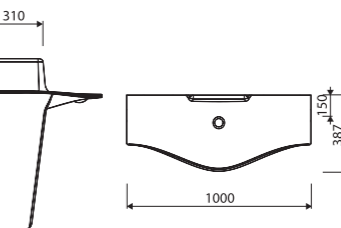
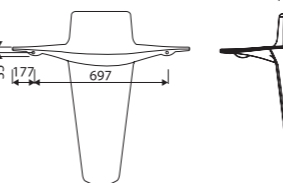

with or without tap opening,
without overflow

LENGTH 1000
WIDTH 387
HEIGHT 955 mm

UNI

page 37

index:
gelcoat® material: 550 085 022 xx x
gelcoat® mat material: 550 085 042 xx x

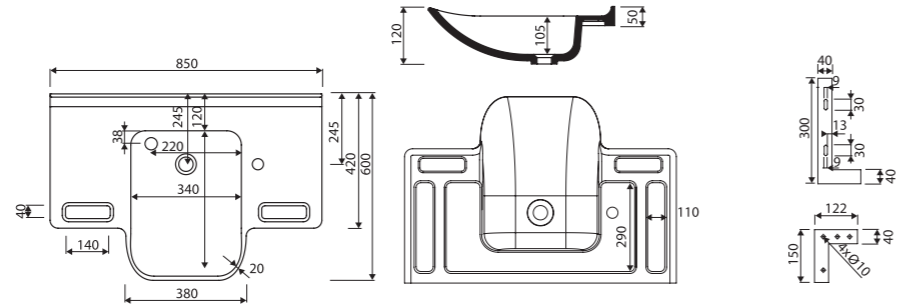

LENGTH 850
WIDTH 600
HEIGHT 120 mm

with or without tap opening,
with or without overflow

recommended mounting method:
wall-mounted

mounted on the
brackets

DISA 50

page 41

index:
gelcoat® material: 130 050 020 xx x
gelcoat® mat material: 130 050 040 xx x

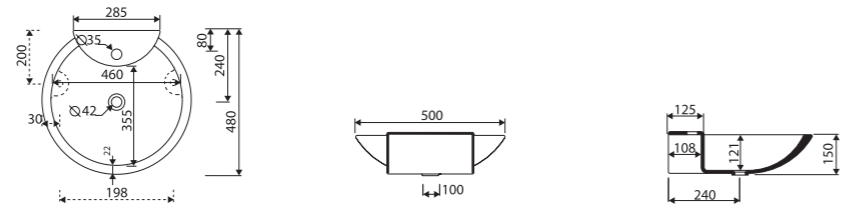

LENGTH 500
WIDTH 480
HEIGHT 150 mm

with tap opening,
without overflow

recommended mounting method:
countertop

DISA 60

page 41

index:
gelcoat® material: 130 060 020 xx x
gelcoat® mat material: 130 060 040 xx x

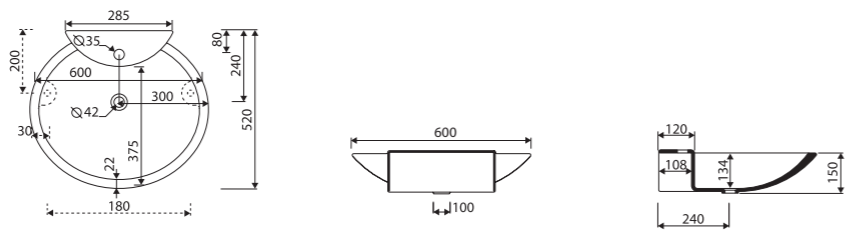

LENGTH 600
WIDTH 520
HEIGHT 150 mm

with tap opening,
without overflow

recommended mounting method:
countertop

ATRIA

page 41

index:
gelcoat® material: 150 065 020 xx x
gelcoat® mat material: 150 065 040 xx x

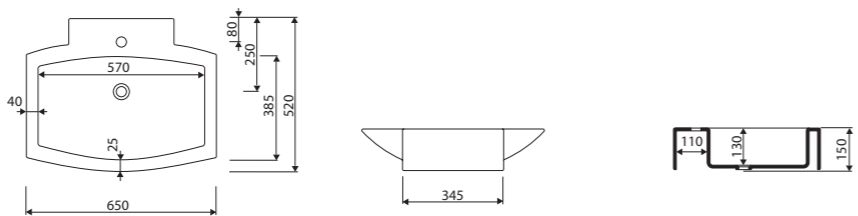

LENGTH 650
WIDTH 520
HEIGHT 150 mm

with tap opening,
without overflow

recommended mounting method:
countertop

DELIA

page 41

index:
gelcoat® material: 140 063 021 xx x
gelcoat® mat material: 140 063 041 xx x

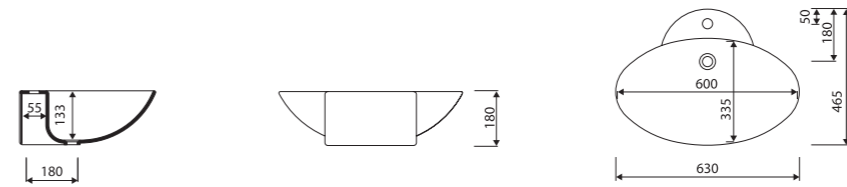

LENGTH 630
WIDTH 465
HEIGHT 180 mm

recommended mounting method:
countertop

with tap opening,
with overflow

FAMA LEG

index: 566 016 01 (white)
index: 566 016 02 (black)

LENGTH 155
WIDTH 135
HEIGHT 310 mm

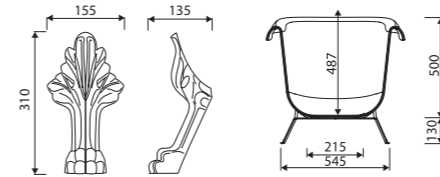

recommended mounting method:
free-standing

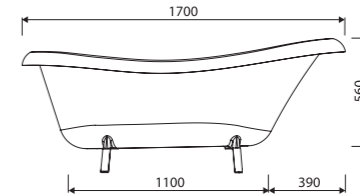

FAMA BATHTUB

page 41

index:
gelcoat® material: 566 173 020 xx x



LENGTH 1700
WIDTH 762
HEIGHT 560 mm

without tap opening,
with or without overflow

ELARA 1

page 42

index:
gelcoat® material: 390 040 020 xx x
gelcoat® mat material: 390 040 040 xx x

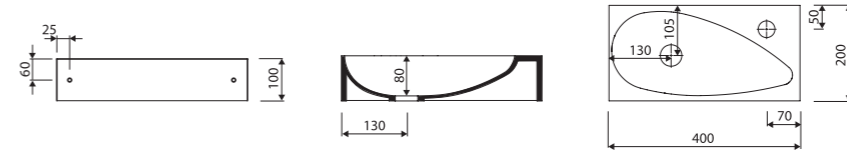

recommended mounting method:
countertop, vanity unit, wall-mounted

with or without tap opening,
without overflow

LENGTH 400
WIDTH 200
HEIGHT 100 mm

ELARA 2

page 42

index:
gelcoat® material: 400 040 020 xx x
gelcoat® mat material: 400 040 040 xx x

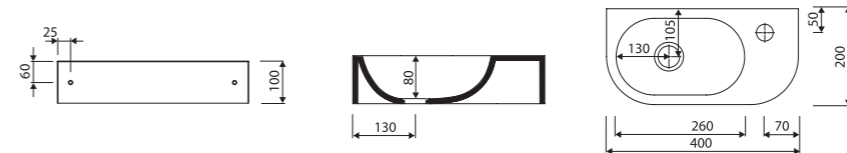

recommended mounting method:
countertop, vanity unit, wall-mounted

with or without tap opening,
without overflow

LENGTH 400
WIDTH 200
HEIGHT 100 mm

ELARA 3

page 42

index:
gelcoat® material: 410 040 020 xx x
gelcoat® mat material: 410 040 040 xx x

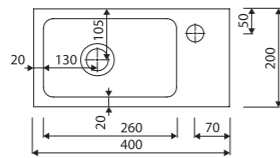

with or without tap opening,
without overflow

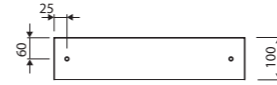
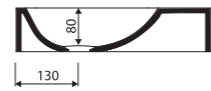

recommended mounting method:
countertop, vanity unit, wall-mounted

LENGTH 400 WIDTH 200 HEIGHT 100 mm

ELARA 4

page 42

index:
gelcoat® material: 420 040 020 xx x
gelcoat® mat material: 420 040 040 xx x

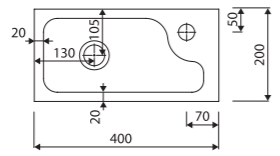

with or without tap opening,
without overflow

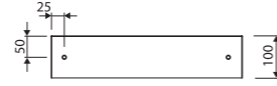
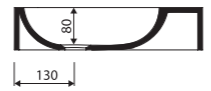

recommended mounting method:
countertop, vanity unit, wall-mounted

LENGTH 400 WIDTH 200 HEIGHT 100 mm

MOIRA BIS 60

page 43

index:
gelcoat® material: 280 060 022 xx x
gelcoat® mat material: 280 060 042 xx x

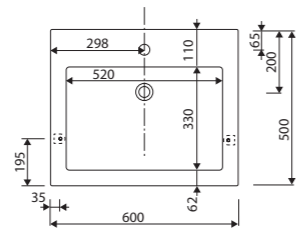

with or without tap opening,
with or without overflow

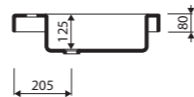
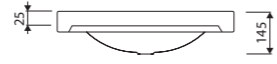

recommended mounting method:
countertop, vanity unit

LENGTH 600 WIDTH 500 HEIGHT 145 mm

MOIRA BIS 70

page 43

index:
gelcoat® material: 280 070 022 xx x
gelcoat® mat material: 280 070 042 xx x

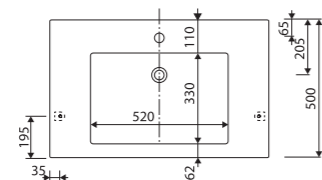

with or without tap opening,
with or without overflow

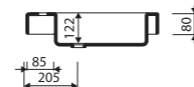
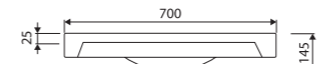

recommended mounting method:
countertop, vanity unit

LENGTH 700 WIDTH 500 HEIGHT 145 mm

MOIRA BIS 80

page 43

index:
gelcoat® material: 280 080 022 xx x
gelcoat® mat material: 280 080 042 xx x

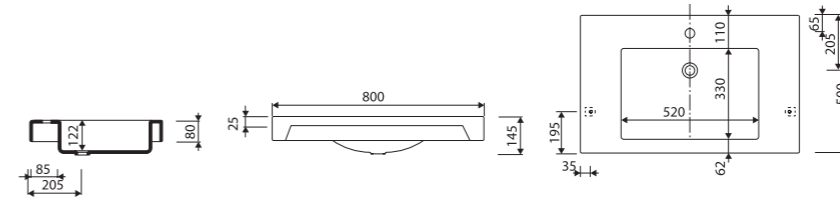

with or without tap opening,
with or without overflow

recommended mounting method:
countertop, vanity unit

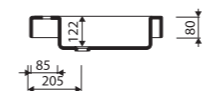

LENGTH 800 WIDTH 500 HEIGHT 145 mm

MOIRA BIS 90

page 43

index:
gelcoat® material: 280 090 022 xx x
gelcoat® mat material: 280 090 042 xx x

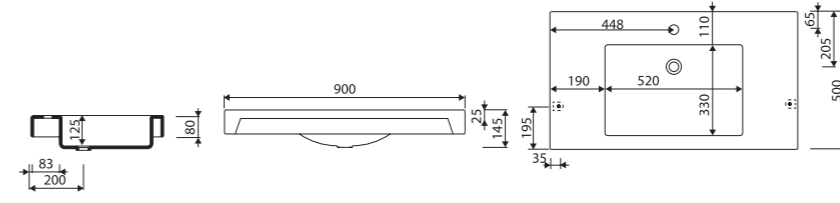

with or without tap opening,
with or without overflow

recommended mounting method:
countertop, vanity unit

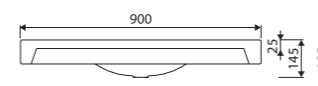
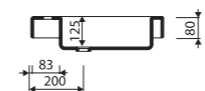

LENGTH 900 WIDTH 500 HEIGHT 145 mm

MOIRA BIS 120

page 43

index:
gelcoat® material: 280 120 022 xx x
gelcoat® mat material: 280 120 042 xx x

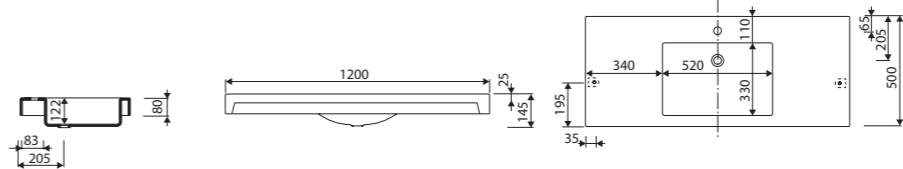

with or without tap opening,
with or without overflow

recommended mounting method:
countertop, vanity unit

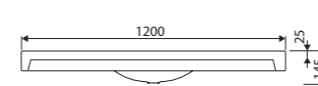
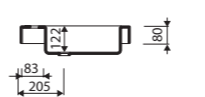

LENGTH 1200 WIDTH 500 HEIGHT 145 mm

MOIRA BIS 120 DUET

page 43

index:
gelcoat® material: 280 120 222 xx x
gelcoat® mat material: 280 120 242 xx x

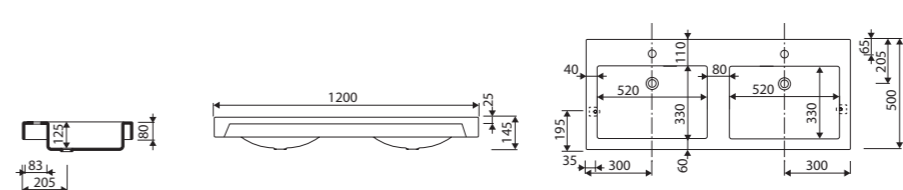

with two tap openings or without openings,
with overflow

recommended mounting method:
countertop, vanity unit

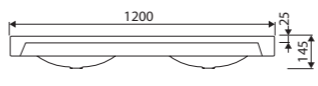
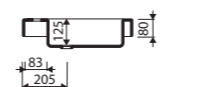

LENGTH 1200 WIDTH 500 HEIGHT 145 mm

LARISSA 60 page 45

index:
gelcoat® material: 300 060 022 xx x
gelcoat® mat material: 300 060 042 xx x

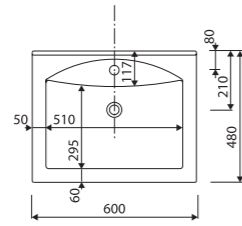

with or without tap opening,
with or without overflow



recommended mounting method:
countertop, vanity unit

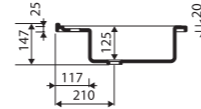

LENGTH 600
WIDTH 480
HEIGHT 147 mm

LARISSA 90 L/R page 45

LARISSA 90 L index:
gelcoat® material: 300 090 722 xx x
gelcoat® mat material: 300 090 742 xx x

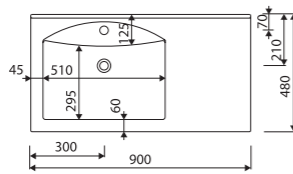

with or without tap opening,
with or without overflow



recommended mounting method:
countertop, vanity unit

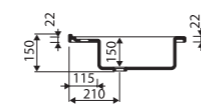

LENGTH 900
WIDTH 480
HEIGHT 150 mm

LARISSA 120 page 45

index:
gelcoat® material: 300 120 022 xx x
gelcoat® mat material: 300 120 042 xx x

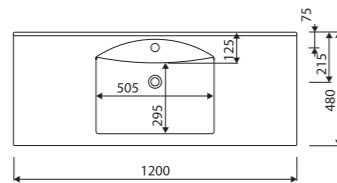

with or without tap opening,
with or without overflow

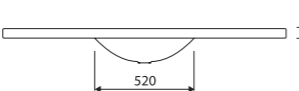

recommended mounting method:
countertop, vanity unit

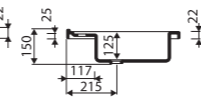

LENGTH 1200
WIDTH 480
HEIGHT 150 mm

LARISSA HOTEL page 45

index:
gelcoat® material: 301 120 022 xx x
gelcoat® mat material: 301 120 042 xx x

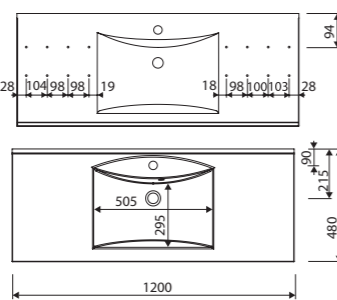

with or without tap opening,
with or without overflow

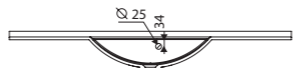

recommended mounting method:
vanity unit, wall-mounted

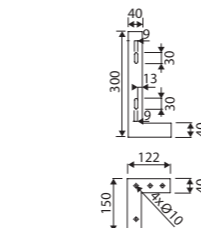

mounted on the brackets
special dimensions for individual request

LENGTH 1200
WIDTH 480
HEIGHT 145 mm

HALE page 45

index:
gelcoat® material: 340 180 021 xx x
gelcoat® mat material: 340 180 041 xx x

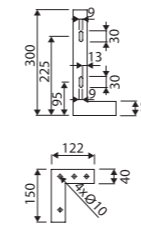

mounted on the brackets
special dimensions for individual request

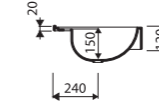

recommended mounting method:
wall-mounted

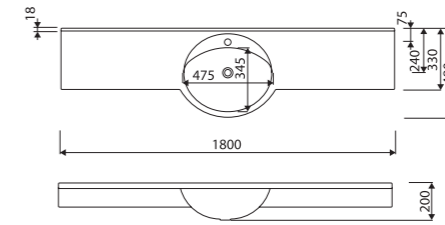

with or without tap opening,
with overflow

LENGTH 1800
WIDTH 480
HEIGHT 200 mm

ONDA page 45

index:
gelcoat® material: 330 120 022 xx x
gelcoat® mat material: 330 120 042 xx x

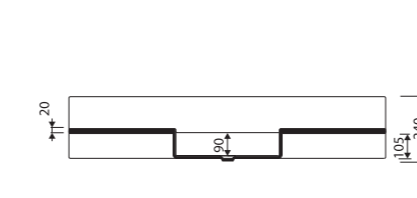

recommended mounting method:
vanity unit

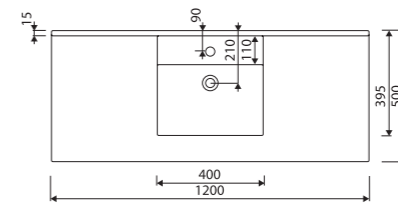

with tap opening,
with or without overflow

LENGTH 1200
WIDTH 500
HEIGHT 240 mm

LA DONNA WASHBASIN page 46

index:
gelcoat® material: 565 070 020 xx x
gelcoat® mat material: 565 070 040 xx x

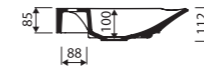

recommended mounting method:
countertop, vanity unit, wall-standing

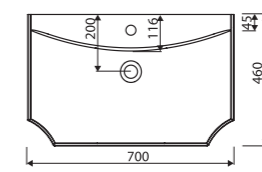
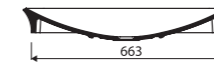

with or without tap opening,
without overflow

LENGTH 700
WIDTH 460
HEIGHT 112 mm

LA DONNA LEG page 46

index:
gelcoat® material: 565 078 020 xx
gelcoat® mat material: 565 078 040 xx

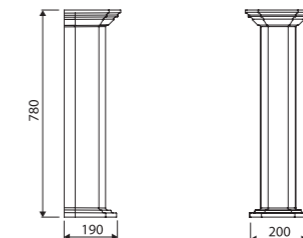

LENGTH 200
WIDTH 190
HEIGHT 780 mm

ROSA 90 SQUARE SHOWER TRAY

page 47

index:
gelcoat® material: 250 090 2xx
gelcoat® mat material: 250 090 4xx

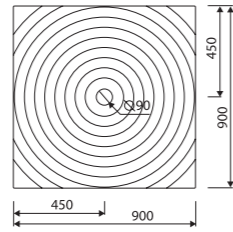
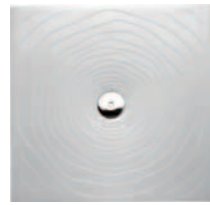

LENGTH 900
WIDTH 900
HEIGHT 60 mm

drain diameter: 90 mm

ROSA 90 ROUND SHOWER TRAY

page 47

index:
gelcoat® material: 255 090 2xx
gelcoat® mat material: 255 090 4xx

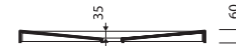
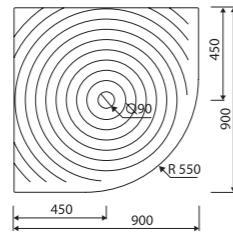
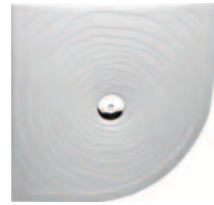

LENGTH 900
WIDTH 900
HEIGHT 60 mm

drain diameter: 90 mm

shower tray radius: 550 mm

MODICO I RECTANGULAR SHOWER TRAY

page 47

index:
gelcoat® material: 269 129 2xx
gelcoat® mat material: 269 129 4xx

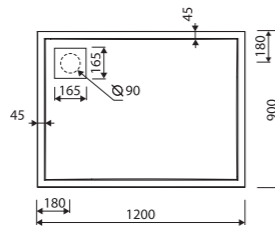

LENGTH 1200
WIDTH 900
HEIGHT 60 mm

drain diameter: 90 mm

MODICO I RECTANGULAR SHOWER TRAY

page 47

index:
gelcoat® material: 269 128 2xx
gelcoat® mat material: 269 128 4xx

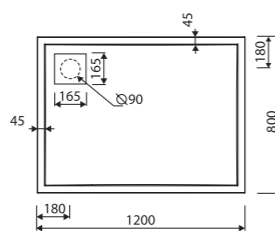

LENGTH 1200
WIDTH 800
HEIGHT 60 mm

drain diameter: 90 mm

MODICO II RECTANGULAR SHOWER TRAY

page 47

index:
gelcoat® material: 279 129 2xx
gelcoat® mat material: 279 129 4xx

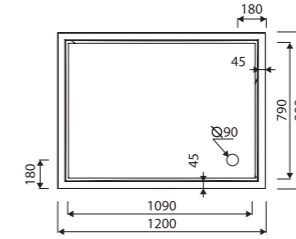

drain diameter: 90 mm

LENGTH 1200
WIDTH 900
HEIGHT 60 mm

CETI 80 SQUARE SHOWER TRAY

page 47

index:
gelcoat® material: 180 080 2xx
gelcoat® mat material: 180 080 4xx

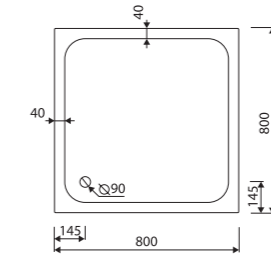

drain diameter: 90 mm

LENGTH 800
WIDTH 800
HEIGHT 55 mm

CETI 90 SQUARE SHOWER TRAY

page 48

index:
gelcoat® material: 180 090 2xx
gelcoat® mat material: 180 090 4xx

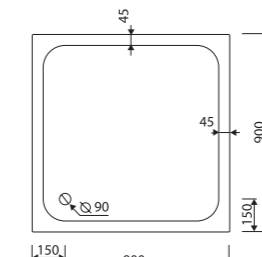

drain diameter: 90 mm

LENGTH 900
WIDTH 900
HEIGHT 55 mm

CETI 80 ROUND SHOWER TRAY

page 48

index:
gelcoat® material: 185 080 2xx
gelcoat® mat material: 185 080 4xx

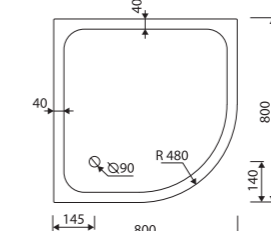

shower tray radius: 480 mm

drain diameter: 90 mm

LENGTH 800
WIDTH 800
HEIGHT 45 mm

CETI 90 ROUND SHOWER TRAY

page 48

index:
 gelcoat® material: 185 090 2xx
 gelcoat® mat material: 185 090 4xx

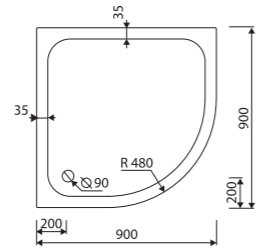

LENGTH 900
 WIDTH 900
 HEIGHT 55 mm

drain diameter: 90 mm

shower tray radius: 480 mm

OTERO 80 ROUND SHOWER TRAY

page 48

index:
 gelcoat® material: 285 080 2xx
 gelcoat® mat material: 285 080 4xx

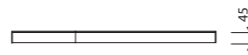
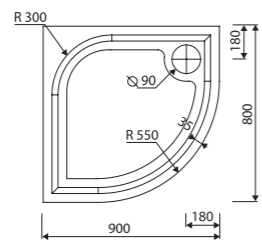

LENGTH 800
 WIDTH 800
 HEIGHT 45 mm

drain diameter: 90 mm

shower tray radius: 550 mm

OTERO 90 ROUND SHOWER TRAY

page 48

index:
 gelcoat® material: 285 090 2xx
 gelcoat® mat material: 285 090 4xx

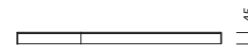
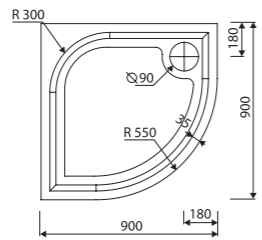

LENGTH 900
 WIDTH 900
 HEIGHT 45 mm

drain diameter: 90 mm

shower tray radius: 550 mm

DIONE SQUARE SHOWER TRAY

page 48

index:
 gelcoat® material: 490 090 2xx
 gelcoat® mat material: 490 090 4xx

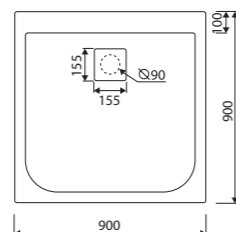

LENGTH 900
 WIDTH 900
 HEIGHT 100 mm

drain diameter: 90 mm



TIME FLIES.
 SOMETHING IS INNOVATIVE TODAY AND
 TOMORROW IT BECOMES A STANDARD.
 THAT IS WHY OUR ACTIVITIES MUST ALWAYS
 BE ONE STEP AHEAD.

marmorin

DESIGNSTUDIO

Searching for ideal design to suit the tastes of our customers as well as to meet the requirements of interior design and the character of each house – these are the tasks realized by our design office.

Tasks – challenge.

It requires profound knowledge within the history of architecture as well as the familiarity with the newest interior design trends.

In the Marmorin Design Studio we create exquisite, unique and luxurious products. We welcome new designers, and proudly cooperate with acknowledged Polish interior designers.

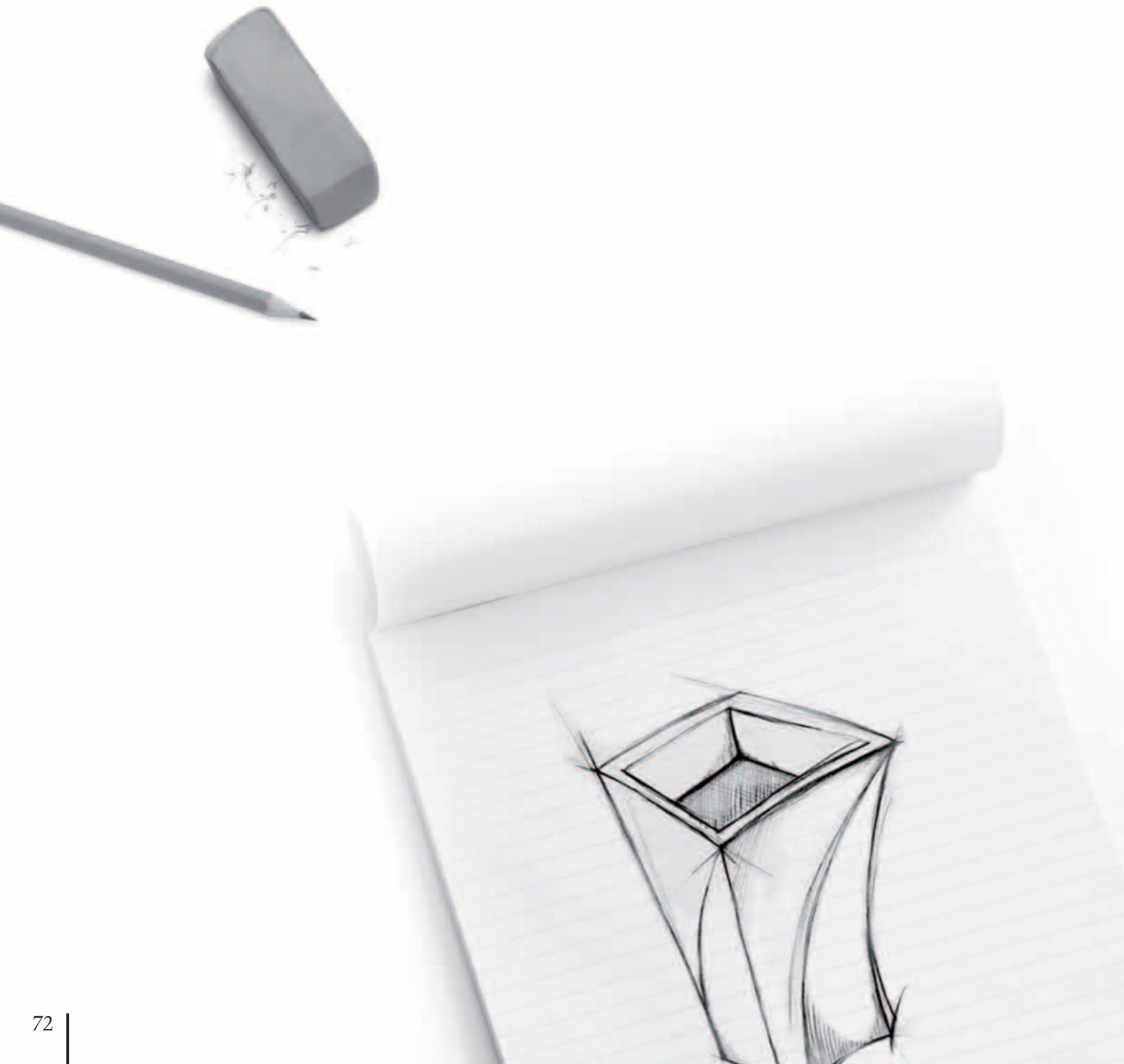

MARCIN JĘDRZAK

(born in 1970) graduated from the Faculty of Industrial Design at the Academy of Fine Arts in Poznań. He is a designer and a decorator, since 1999 he has run his own design studio Jędrzak Design. He has designed for Marmorin since 2001.



PIOTR WEŁNIAK

(born in 1972) graduated from the Faculty of Interior and Industrial Design as well as the Faculty of Sculpture at the Academy of Fine Arts in Poznań. He is a designer and a decorator. He designs furniture, interiors, spatial forms and architecture. For years he has worked for the Design Group ETE. He has cooperated with Marmorin company since 2004.



ANITA CHUDECKA

(born in 1972) graduated from the Department of Architecture and Urban Design at the Poznan University of Technology and completed post-graduate studies at the School of Humanities and Journalism in Poznan majoring in Diplomacy and Negotiations. Her everyday occupation includes designing of public use buildings, clinics and houses. She is passionately dedicated to interior design and designing furniture. She has been cooperating with Marmorin since 2010.



MONIKA ELIKOWSKA-OPALA, WOJCIECH OPALA

(born in 1983), (born in 1980) graduated from the Academy of Fine Arts in Poznań, Faculty of Architecture and Design and received a diploma in furniture design. In 2010 they co-established a design studio, i.e. the MOWOstudio designing products, furniture and providing services within interior architecture. They cooperate with manufacturing companies and co-create projects for individual customers. They have been designing for Marmorin since 2010.



MICHAŁ KORSUN

(born in 1971) completed the Faculty of Industrial Design at the Academy of Fine Arts in Warsaw. He is an industrial designer, creator of posters, illustrator and has been developing his brand, KorsunDesign, since 2008. He has been the designer for Marmorin since 2010.



ANNA DUL

(born in 1986) graduated from the Department of Architecture and Design at the Academy of Fine Arts in Poznań; she received a diploma in furniture design. She is a product and furniture designer as well as an interior designer. Within an Educational and Design Programme she has designed the UNI sink for Marmorin which was honoured at the contest entitled "i-Wielkopolska – Innovative for the Wielkopolskie region" organized by the Marshal's Office of the Wielkopolskie Region.



MONIKA BŁASZKOWSKA

(born in 1980) graduate of the Department of Architecture and Urban Development on the Gdańsk University of Technology. She has been conducting business activity within the scope of interior and industrial design since 2005. She is the owner of Moka design which includes in its portfolio numerous interior designs of commercial buildings (mainly medical interiors) in all Poland.



MARCIN KONICKI

(born in 1980) in Połczyn Zdrój graduated from the Department of Architecture and Design of the Fine Arts Academy in Poznań. He obtained a diploma in design with honours. In 2006 he co-created the + - Design studio specialising in product and furniture design, graphics, interior design and cooperating with many companies.

TECHNOLOGIES AND MATERIALS:

GELCOAT® MATERIAL / *GELCOAT*® MAT MATERIAL

In simple words, cultured marble is a dolomite ground into powder and combined with resin. We were the pioneers with regard to this technology; as the first ones in Poland we developed our own cultured marble with unique parameters.

The secret is within the appropriate proportions of the filling material which is a mix of selected dolomite fractions enriched with purifiers combined with resin. This technology allowed us to obtain a monolithic filling material which entirely lacks micro air bubbles which simultaneously prevents the material from separating from the gelcoat.

SOLID® MATERIAL

This is a type of uniform mass combining resin with aluminium oxides. Sinks made in this technology may be glossy or matte. An additional advantage of such products is its lack of combustibility. The Solid® Material products are highly appreciated in Europe and United States.

FEATURES:



UV



stain
resistant



range
of colors



easy
for cleaning



ecological



heat shock-resistant



shock-resistant



special
dimension

AWARDS



GOOD CHOICE 2012



PRODUCT RECOMMENDED TO 'GOOD CHOICE 2013' COMPETITION



PRODUCT RECOMMENDED TO 'GOOD CHOICE 2011' COMPETITION



PRODUCT RECOMMENDED TO 'GOOD CHOICE 2010' COMPETITION



FINALIST OF 'GOOD CHOICE 2010' COMPETITION



TOP DESIGN AWARD 2011



TOP DESIGN AWARD 2010



BATHROOM – CHOICE OF THE YEAR 2010



reddot design award
honourable mention 2011

RED DOT DESIGN AWARD



MUST HAVE 2012



MUST HAVE 2011



EUROPEAN MEDAL 2012



EUROPEAN MEDAL 2011



THE BEST IN POLAND



AMBASSADOR OF POLISH ECONOMY

CERTIFICATES



ISO 14001
ISO 9001



LGA HYGIENE TESTED



HYGIENIC CERTIFICATE



WE OWN A RESEARCH LABORATORY



"THE RESEARCH LABORATORY WAS ACKNOWLEDGED BY TÜV RHEINLAND POLSKA SP. Z O.O." ACKNOWLEDGMENT CERTIFICATE NO.: TÜV - LAB - 02

